

## KAWASAKI NINJA 400 '18-'20

REF 20169N

TAPAS LATERAL IZQUIERDO / LEFT SIDE COVERS



1 Person





30 min



EASY

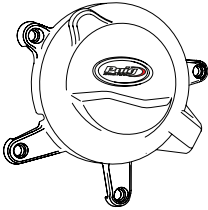

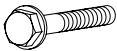
ID.	PIEZA / PART	DESCRIPCIÓN	DESCRIPTION	QTY.	REF.:
1		Tapa izquierda	Left cover	1	CONJUNTO--20169
2		Tornillo M6x40 DIN6921	M6x40 DIN6921 screw	3	-
3		Tornillo M6x45 DIN6921	M6x45 DIN6921 screw	1	-

RECOMENDAMOS MONTAR LOS TORNILLOS APRETANDO UNIFORMEMENTE UNO TRAS OTRO, PARA APRETAR FINALMENTE CON DINAMOMÉTRICA  
WE RECOMMEND TO MOUNT THE SCREWS UNIFORMLY TIGHTENING ONE AFTER THE OTHER, TO FINALLY TIGHTEN WITH DYNAMOMETRIC

# KAWASAKI NINJA 400 '18-'20

REF 20169N

INSTRUCCIONES DE MONTAJE - MOUNTING INSTRUCTIONS - MONTAGEANLEITUNG

**1**

ASSEMBLY  
MONTAJE

**2-3**  9,80 N/m - Par de apriete  
7,23 lb/ft - Tightening torque

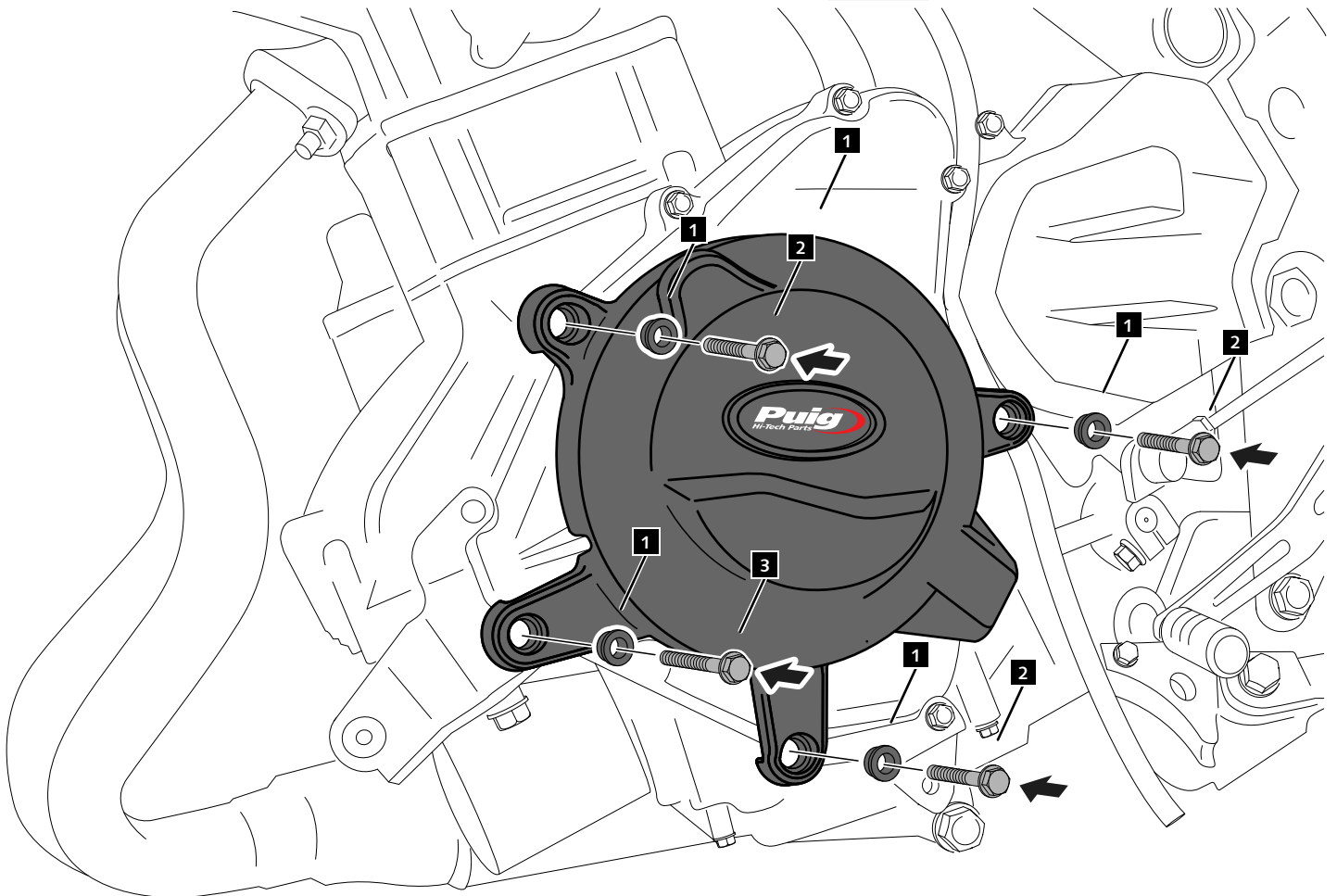
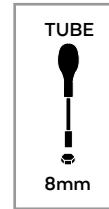

**CONSULTAR EN NUESTRA PAGINA WEB LA DISPONIBILIDAD DEL VIDEO DE MONTAJE DE ESTA REFERENCIA.  
CONSULT OUR WEBSITE THE VIDEO MOUNT AVAILABILITY OF THIS REFERENCE.**

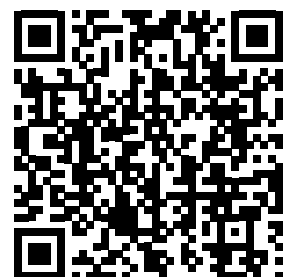

## KAWASAKI NINJA 400 '18-'20

REF 20169N

TAPAS LATERAL DERECHO / RIGHT SIDE COVERS



1 Person



30 min



EASY



ID.	PIEZA / PART	DESCRIPCIÓN	DESCRIPTION	QTY.	REF.:
1		Tapa derecha 1	Right cover 1	1	CONJUNTO--20169
2		Tapa derecha 2	Right cover 2	1	CONJUNTO--20169
3		Tornillo M6x20 DIN6921	M6x20 DIN6921 screw	1	-
4		Tornillo M6x35 DIN6921	M6x35 DIN6921 screw	2	-
5		Tornillo M6x45 DIN6921	M6x45 DIN6921 screw	1	-
6		Tornillo M6x55 DIN6921	M6x55 DIN6921 screw	3	-

RECOMENDAMOS MONTAR LOS TORNILLOS APRETANDO UNIFORMEMENTE UNO TRAS OTRO, PARA APRETAR FINALMENTE CON DINAMOMÉTRICA  
WE RECOMMEND TO MOUNT THE SCREWS UNIFORMLY TIGHTENING ONE AFTER THE OTHER, TO FINALLY TIGHTEN WITH DYNAMOMETRIC

# KAWASAKI NINJA 400 '18-'20

REF 20169N

INSTRUCCIONES DE MONTAJE - MOUNTING INSTRUCTIONS - MONTAGEANLEITUNG

**1**

ASSEMBLY  
MONTAJE

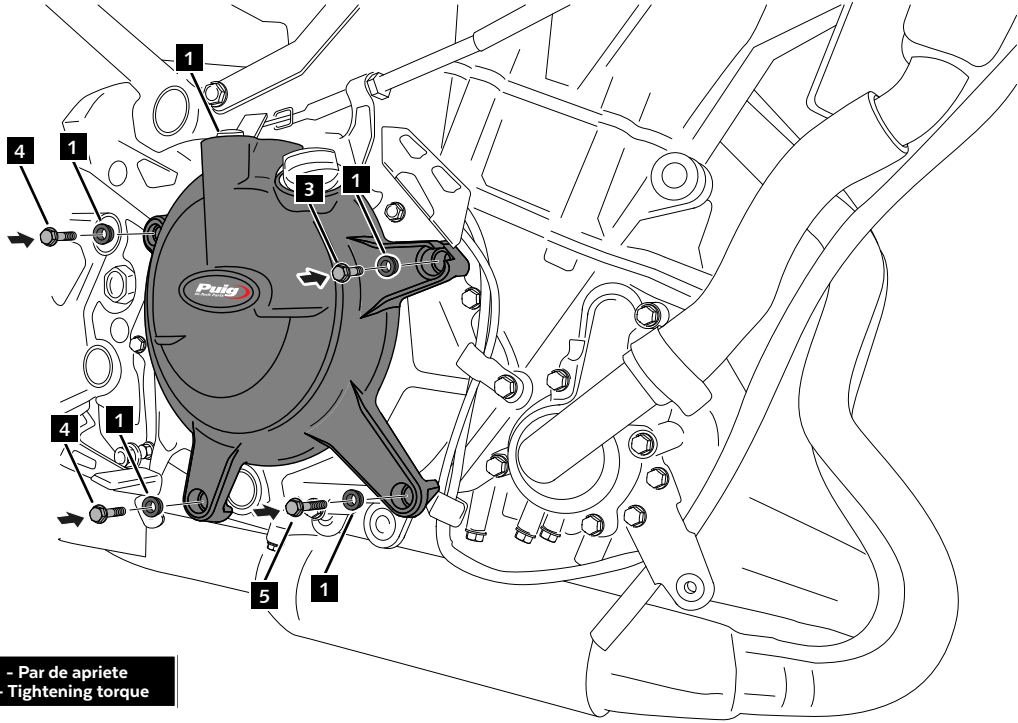

TUBE



8mm

**3-4-5**



9,80 N/m - Par de apriete  
7,23 lb/ft - Tightening torque

**2**

ASSEMBLY  
MONTAJE

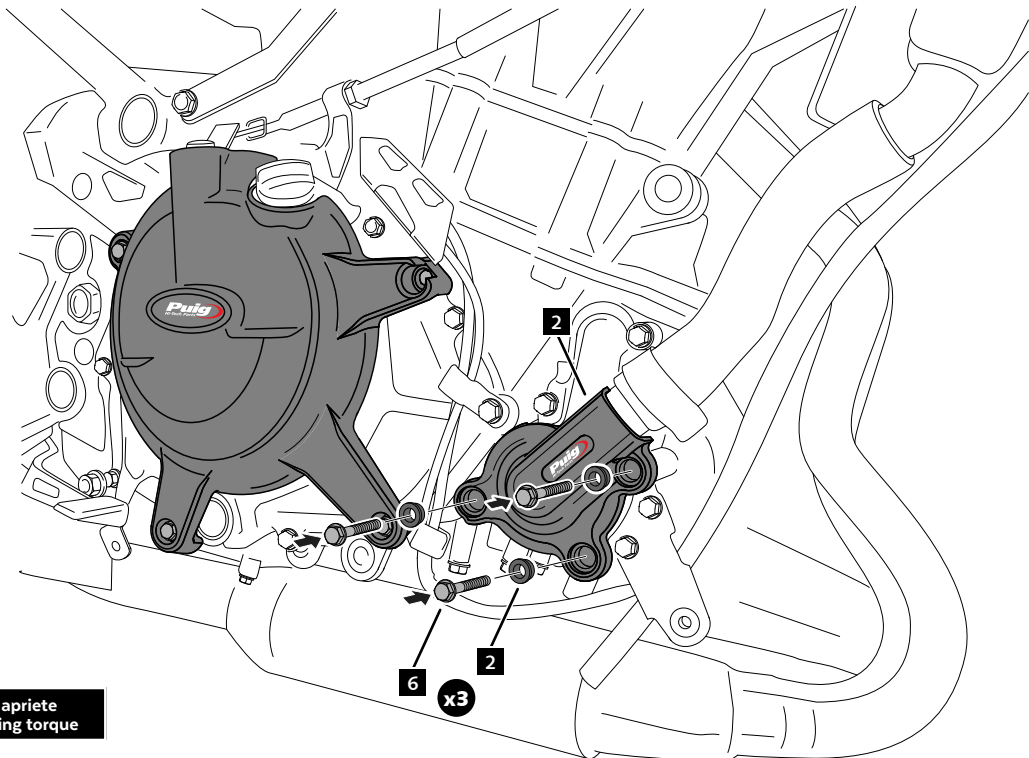

TUBE



8mm

**6**



9,80 N/m - Par de apriete  
7,23 lb/ft - Tightening torque