

MOTOPLASTIC, S.A.

Molí de la sal, 1 - 08400 Granollers (Barcelona) SPAIN

Tel. 34 93 849 06 33 - Fax 34 93 849 09 88

info@motoplastic.com

www.puig.tv







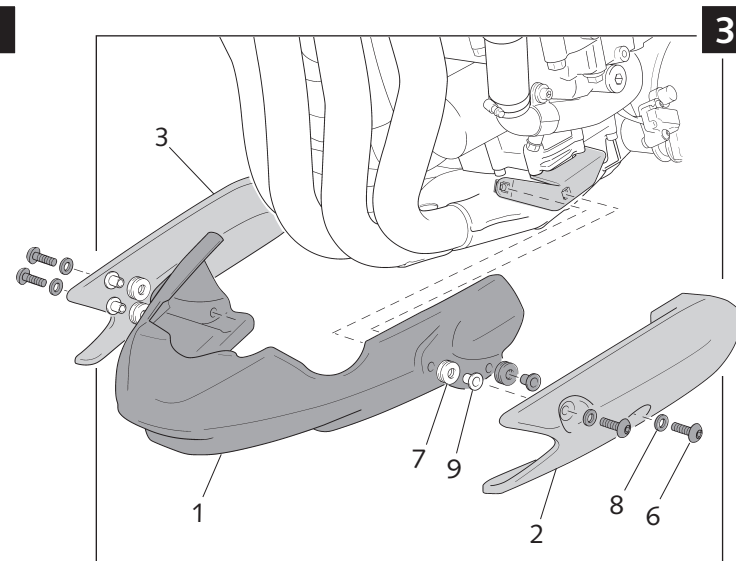
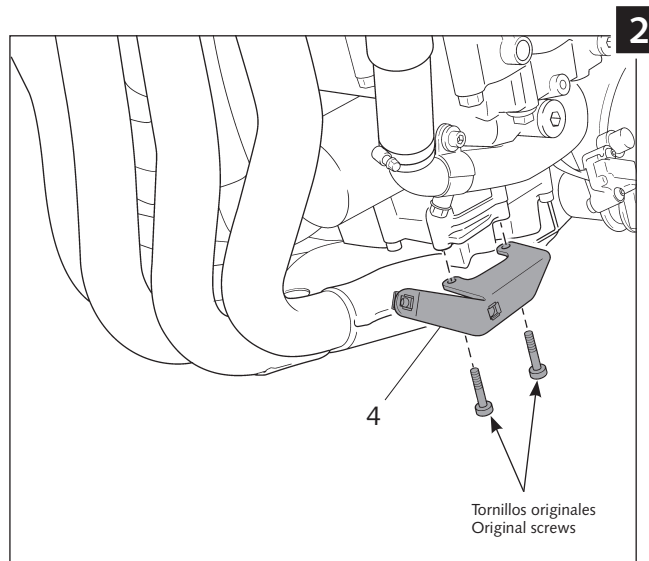
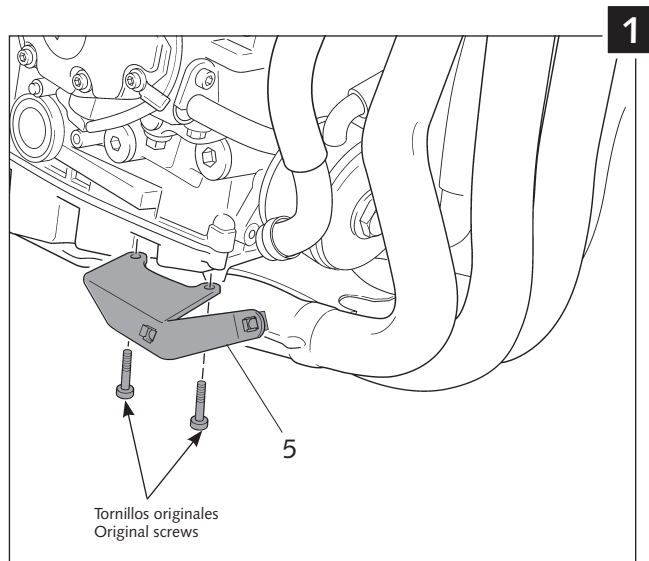

INSTRUCCIONES DE MONTAJE - MOUNTING INSTRUCTIONS

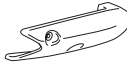
QUILLA ADAPTABLE A - ENGINE SPOILER ADAPTABLE TO YAMAHA FZ1 / FZ1 FAZER

Ref.: 4135N
(color negro/black colour)

Ref.: 4135C
(color carbono/carbon look)



ID.	DESCRIPCIÓN	DESCRIPTION	QTY.
1	 Frontal quilla	Engine spoiler front part	1
2	 Lateral izquierdo quilla	Engine spoiler left part	1
3	 Lateral derecho quilla	Engine spoiler right part	1
4	 Soporte izquierdo INOX con tuerca enjaulada M6	Left stainless steel support with an inside M6 nut	1
5	 Soporte derecho INOX con tuerca enjaulada M6	Right stainless steel support with an inside M6 nut	1
6	 Tornillo allen M6x20 DIN 1001	M6x20 DIN 1001 allen screw	4
7	 Silemblock Ø9Ø11Ø18 (se suministra montado en la pieza nº1)	Ø9Ø11Ø18 well nut (supplied already mounted on the piece nº1)	4
8	 Arandela nylon Ø6	Nylon washer Ø6	4
9	 Casquillo con valona (se suministra montado en la pieza nº1)	Metal arrowhead with washer (supplied already mounted on the piece nº1)	4