

## HONDA REBEL CMX 300-500 '17- / S' 20-

### M O U N T I N G I N S T R U C T I O N S

REF 21061

SEMIFAIRING BATWING SML SPORT MODEL



1 Person



20 min



EASY



**ONLY FOR REBEL "S": ANTES DE INSTALAR EL PRODUCTO, DESMONTAR EL SEMI-FARO ORIGINAL BEFORE INSTALLING THE PRODUCT, TAKE APART THE OEM SEMI-FAIRING**



ALLEN

Nº 3  
Nº 6  
Nº 8



ID	PIEZA/PART	DESCRIPCIÓN	DESCRIPTION	QTY	REF
1		Semicarenado	Semifairing	1	10897J
2		Cúpula Touring	Touring screen	1	10899
3		Soporte derecho superior (SR)	Upper right support	1	SOP4P3SRBTM0002
4		Soporte superior izquierdo (SL)	Upper left support	1	SOP4P3SLBTM0002
5		Soporte inferior derecho (IR)	Lower right support	1	SOP4P3IRBTM0002
6		Soporte inferior izquierdo (IL)	Lower left support	1	SOP4P3ILBTM0002
7		Arandela de goma Ø4,5 x Ø11 x 2mm	Ø4,5 x Ø11 x 2mm rubber washer	2	ARAND-EPDM--722
8		Tornillo Allen M8x45 ISO 7380	M8x45 ISO 7380 Allen screw	2	TORNI-I7380-817
9		Casquillo Ø8x Ø14x 9	Ø8x Ø14x 9 spacer	2	CASQUI-----0100
10		Silentblock M5	M5 silentblock	4	SILENBTM5-046/1
11		Arandela nylon M5x1	M5x1 nylon washer	4	ARNV00000000245
12		Tornillo Allen M5x16 Ø11 ISO 7380	M5x16 Ø11 ISO 7380 Allen screw	6	TORNI-I7380-493
13		Tapón tornillo M5 ISO 7380	M5 ISO 7380 screw cap	4	TAPON-----85
14		Tornillo Allen M4x12 ISO7380	M4x12 ISO 7380 Allen screw	3	TORNI-I7380-800
15		Arandela nylon M4x0,5	M4x0,5 nylon washer	6	ARNV00000000311
16		Tuerca autoblocante M4	M4 nut	3	TUERCAE985-0290
17		Tapón tuerca M4	M4 cap nut	3	TAPON-----91

## HONDA REBEL CMX 300-500 '17- / S' 20-

INSTRUCCIONES DE MONTAJE - MOUNTING INSTRUCTIONS - MONTAGEANLEITUNG

1

DISASSEMBLY  
DESMONTAJE

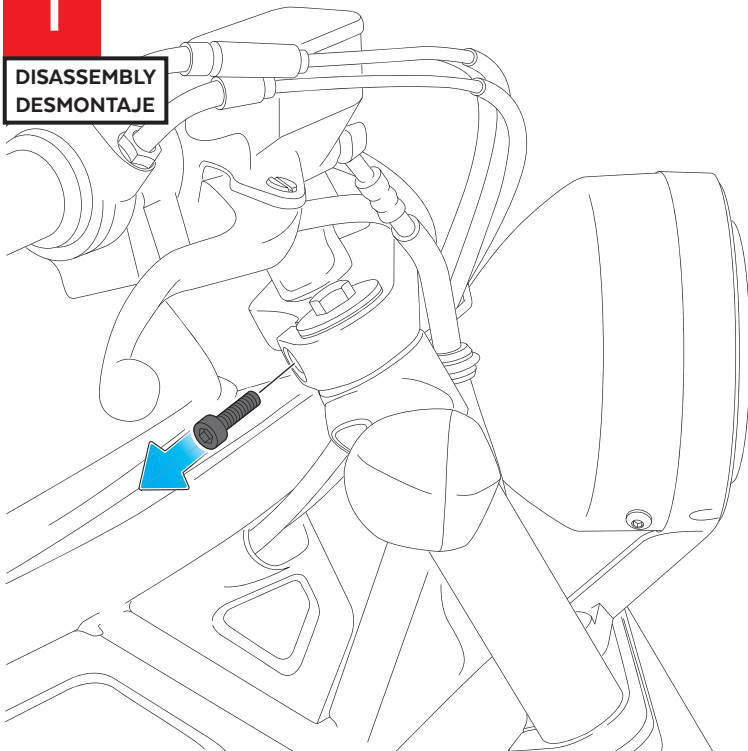

2

ASSEMBLY  
MONTAJE

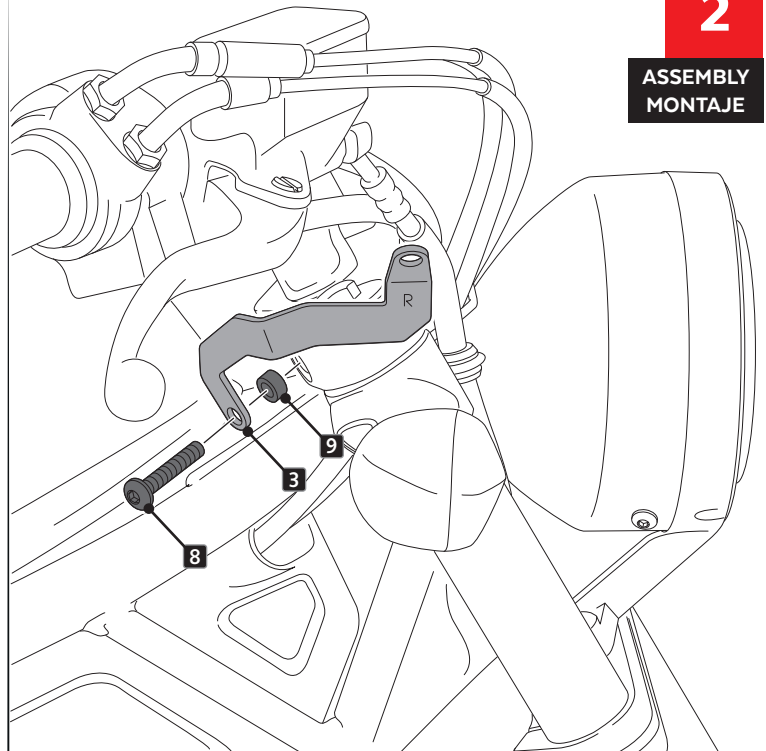

3

DISASSEMBLY  
DESMONTAJE

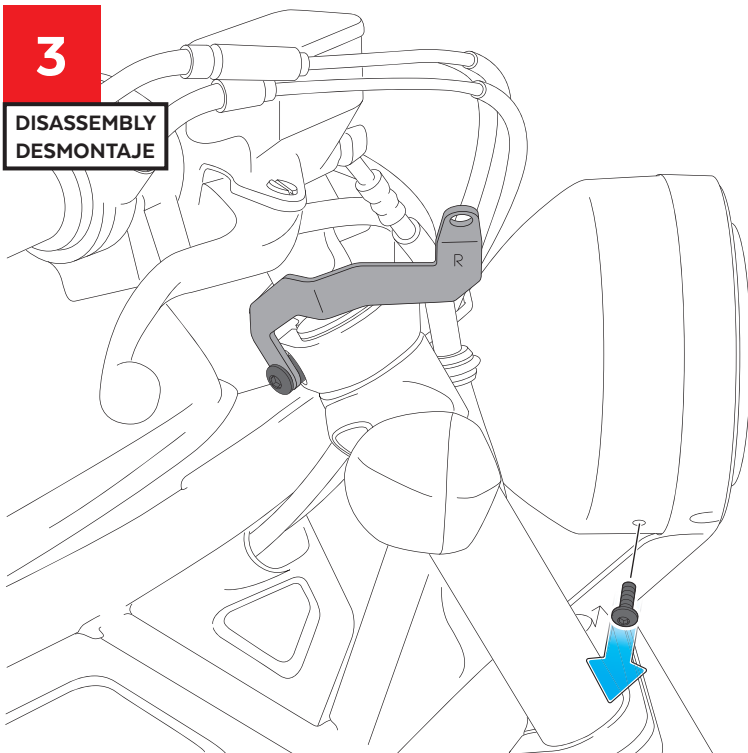

4

ASSEMBLY  
MONTAJE

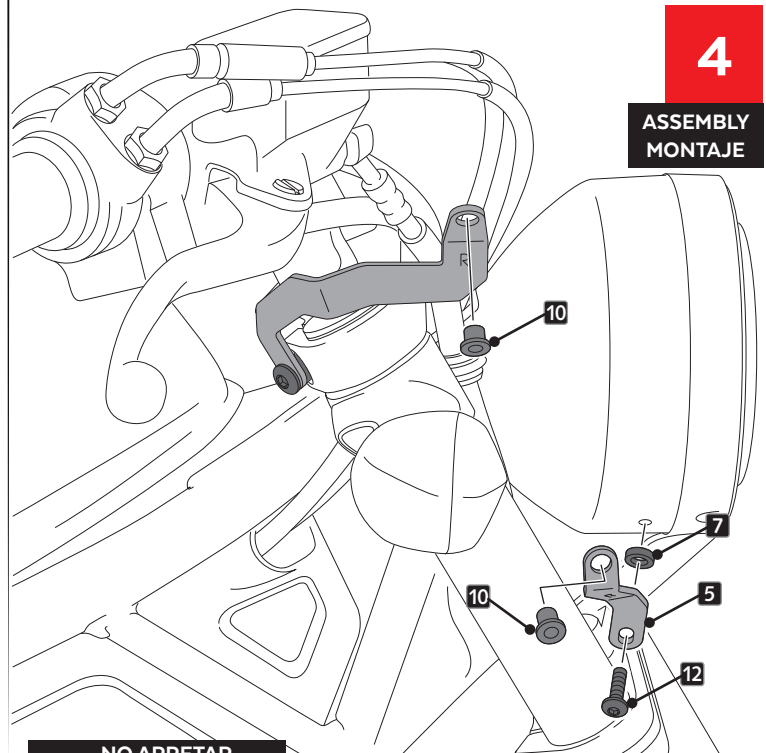

**ID-12** NO APRETAR  
DO NOT TIGHTEN

## HONDA REBEL CMX 300-500 '17- / S' 20-

INSTRUCCIONES DE MONTAJE - MOUNTING INSTRUCTIONS - MONTAGEANLEITUNG

5

DISASSEMBLY  
DESMONTAJE

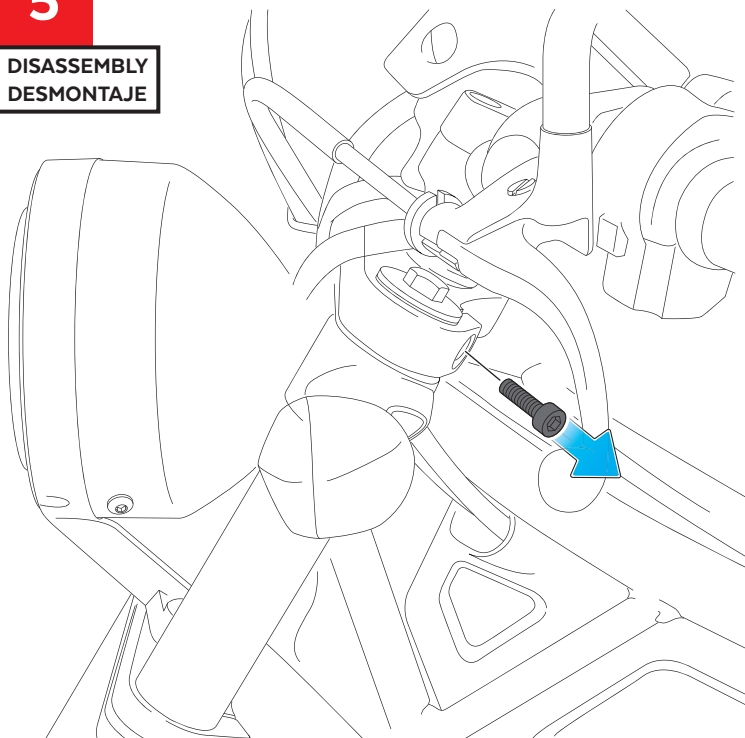

6

ASSEMBLY  
MONTAJE

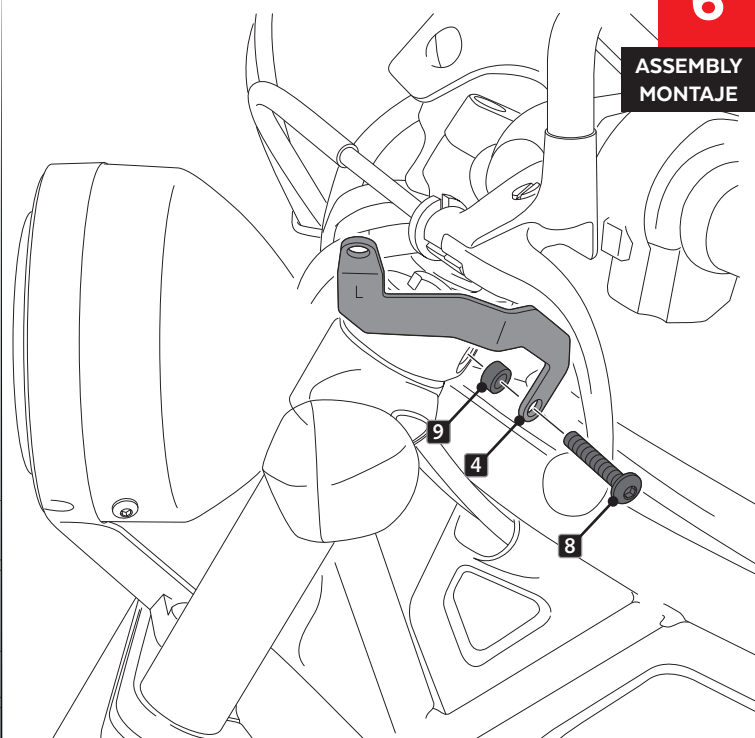

7

DISASSEMBLY  
DESMONTAJE

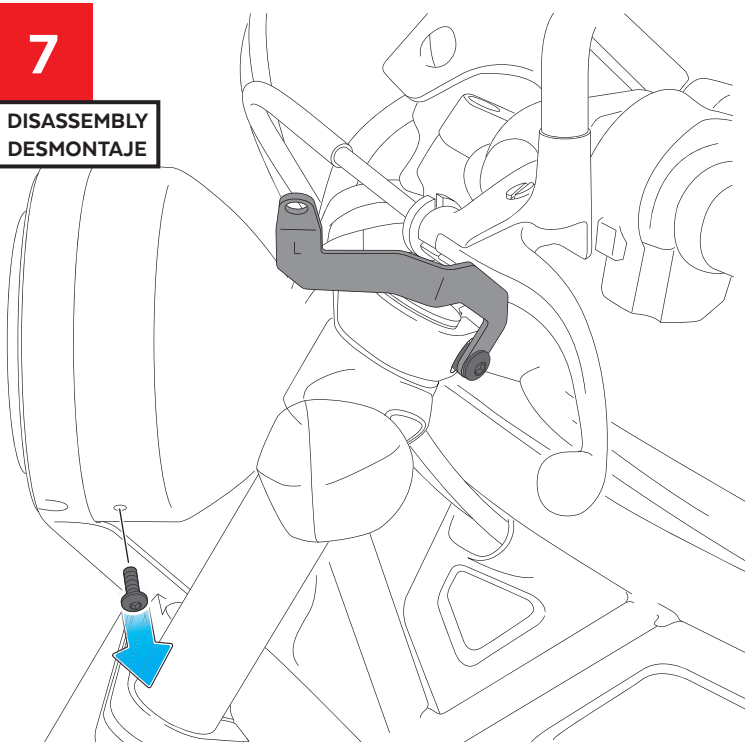

8

ASSEMBLY  
MONTAJE

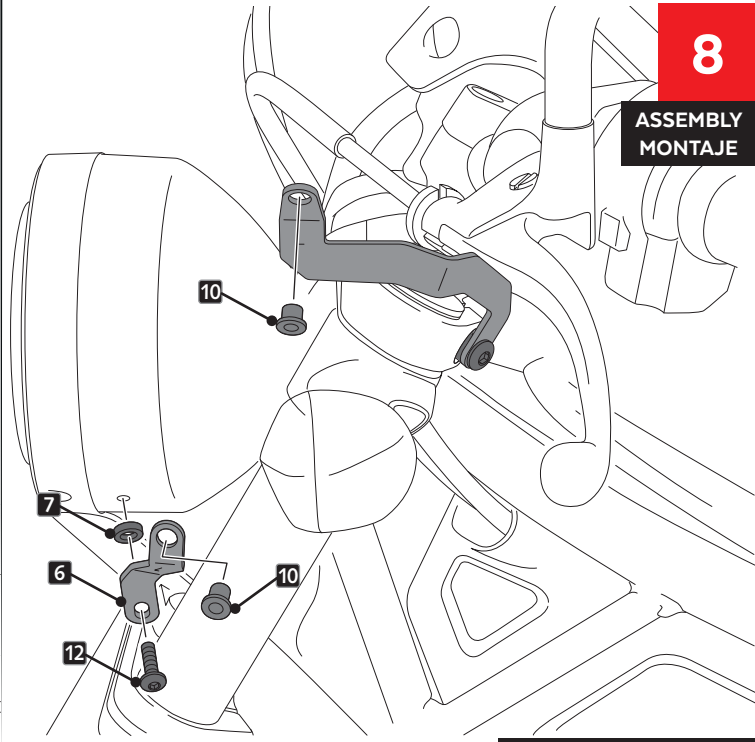

**ID-12** NO APRETAR  
DO NOT TIGHTEN

## HONDA REBEL CMX 300-500 '17- / S' 20-

INSTRUCCIONES DE MONTAJE - MOUNTING INSTRUCTIONS - MONTAGEANLEITUNG

9

ASSEMBLY  
MONTAJE

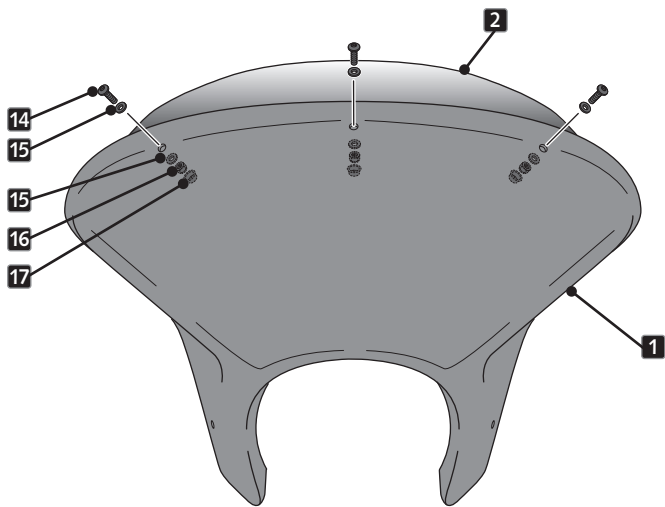

10

ASSEMBLY  
MONTAJE

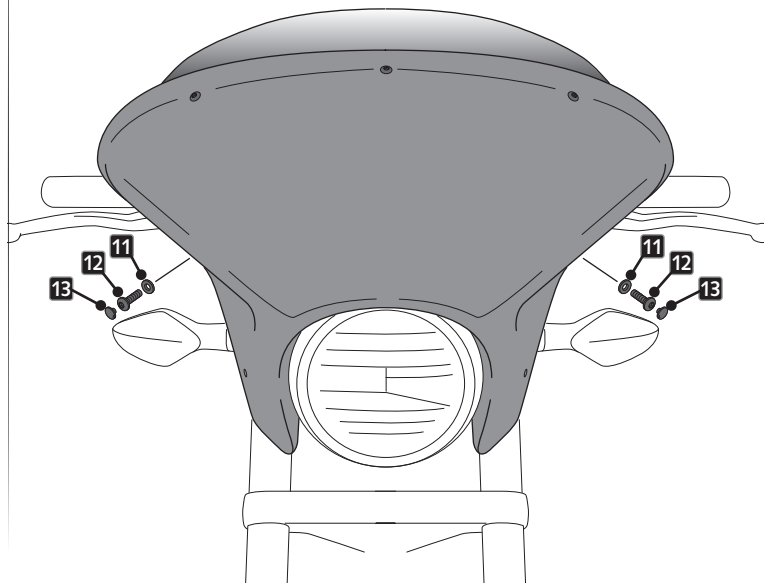

11

ASSEMBLY  
MONTAJE

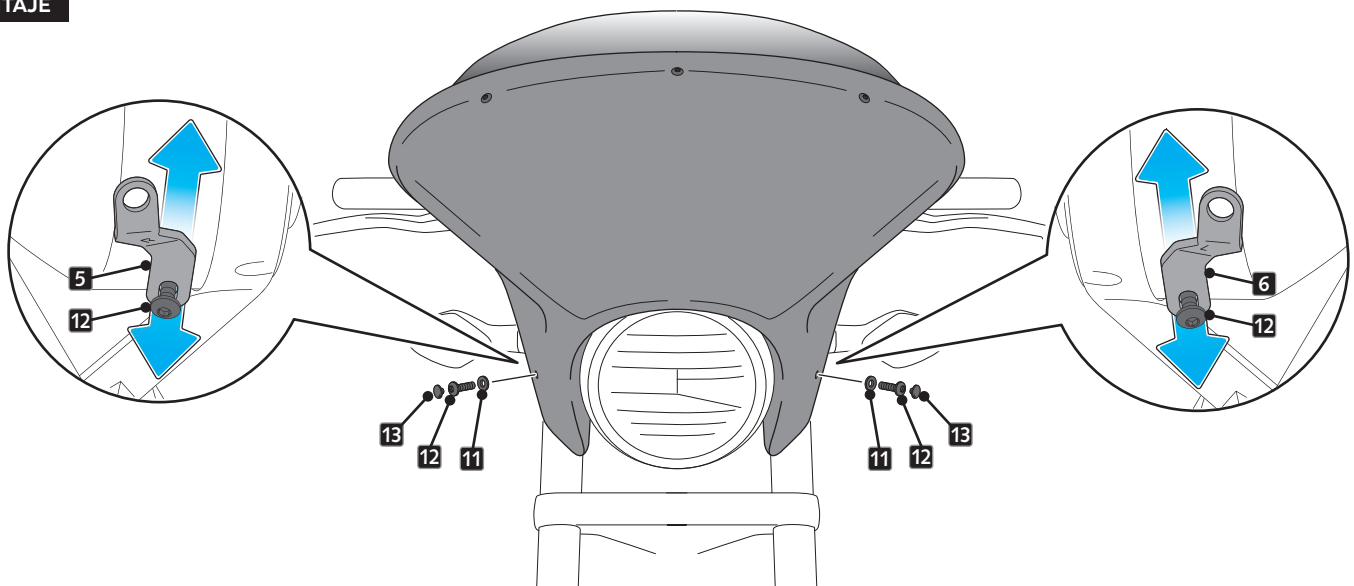

ID-12 AJUSTAR POSICIÓN SOPORTES Y APRETAR EL TORNILLO.  
ADJUST POSITION SUPPORTS AND TIGHTEN ID-12 SCREW.